

INSTALLATION AND OPERATION MANUAL

For
PLASMA III, II+, and II
CDI SYSTEMS

FOUR AND SIX CYLINDER INSTALLATIONS

CONGRATULATIONS ON YOUR PURCHASE OF A LIGHT SPEED ENGINEERING (LSE) PLASMA CAPACITOR DISCHARGE IGNITION (CDI) SYSTEM.

YOU WILL NOW BE ABLE TO EXPERIENCE THE SIGNIFICANT ADVANTAGES OF DISTRIBUTORLESS HIGH ENERGY ELECTRONIC IGNITION IN FLIGHT PERFORMANCE AND EFFICIENCY.

TO ENSURE RELIABLE LONG TERM OPERATION, AND TO ACHIEVE THE FULL PERFORMANCE POTENTIAL, PLEASE READ THE ENTIRE MANUAL CAREFULLY, AND FOLLOW THE PROCEDURES.

SINCERELY,

KLAUS SAVIER, Light Speed Engineering, LLC

LIGHT SPEED ENGINEERING, LLC
MAIL: PO BOX 549, Santa Paula, CA, 93061
UPS/FedEX Physical Address: 416 E. Santa Maria St. HANGAR #15,
SANTA PAULA, CA 93060

Phone: (805) 933-3299

E-mail: klaus@lightspeedengineering.com
or jenny@lightspeedengineering.com

NOTICE

Light Speed Engineering Plasma CD Ignition products are intended only for installation and use on aircraft which are licensed by the FAA in the "*experimental*" category pursuant to a Special Airworthiness Certificate, or aircraft which are the subject of a Supplemental Type Certificate for modifications which include Plasma ignition. All products must be installed and used in accordance with the current instructions from Light Speed Engineering which are available on the website at www.LightSpeedEngineering.com.

WARNING

Failure of the Plasma CD ignition system(s) or products, or improper installation of Plasma ignition systems or products, may create a risk of property damage, severe personal injury or death.

Though a system manual may be shipped with your order, the MOST CURRENT AND COMPLETE version of the INSTALLATION INSTRUCTIONS AND OPERATING MANUAL for each of our products is available on our website under "Manuals", or by calling Light Speed Engineering at 805-933-3299.

ALL SYSTEMS AND PRODUCTS MUST BE INSTALLED ACCORDING TO THE INSTALLMENT INSTRUCTIONS CONTAINED IN THE OPERATING MANUAL POSTED ON OUR WEBSITE.

TABLE OF CONTENTS

Section 1 [PLASMA SYSTEM PARTS LIST](#)

Section 2 [SYSTEM INSTALLATION](#)

2.1 Plasma CD Ignition Module

2.2 Ignition Coils

2.3 Primary Ignition Wires

2.4 High Tension Leads

2.5 Spark Plug Adaptors and Spark Plugs

2.6 Power Supply

2.7 Optional Electrical Connections

2.8 Manifold Pressure Line

2.9 General Installation Instructions

Section 3 [TRIGGER SYSTEM INSTALLATION](#)

3.1 Direct Crank MINI Sensor Installation

A. Lycoming Installation

B. Flywheel Modification

B. Continental, Franklin & Other Engine Installation

3.2 Hall Effect Sensor Module Installation (Available for 4-cyl. Only)

3.3 Direct Crank Sensor Circuit Board Installation

A. Lycoming Installation

B. Continental 550 and Franklin Engines

C. Continental O-200 Engines

Section 4 [MAGNETO REMOVAL & COVER PLATE INSTALLATION](#)

Section 5 [OPERATIONAL TESTING](#)

5.1 Phasing (cylinder firing order)

5.2 Ignition Timing

5.3 Electrical Operating Instructions

5.4 Run Up Tests

5.5 In-flight Tests

Section 6 [INSPECTION AND MAINTENANCE](#)

Section 7 [TROUBLE SHOOTING](#)**7.1 Starting Problems****7.2 Radio Noise****7.3 Timing Test Using A Strobe Light****Flowchart 1: Engine Runs Poorly****Flowchart 2: Engine Does Not Run****Section 8 [FACTORY REPAIR AND WARRANTY](#)****LIST OF FIGURES**

[FIGURE 1. DUAL POWER SUPPLY](#)

[FIGURE 2. Plasma II, II+ & III Input Connector Diagram](#)

[FIGURE 3. Plasma II Plus & III Output Connector Diagram](#)

[FIGURE 4. Dual Ignition Indicator Lights](#)

Section 1 PLASMA SYSTEM PARTS LIST

The LSE **PLASMA CDI** Systems contain the following items. Quantities listed are for single systems and quantities marked with an * are for dual systems. If any items are missing or damaged, contact LSE **immediately**.

Most connections are pre-assembled at LSE, leaving extra length for your installation. If any of the wires are too short, return them unused to LSE with exact dimensions for the length you need. There is no charge for custom wires if the returned wires are unused and returned within 30 days.

<u>DC MINI Sensor</u>	<u>CRANK SENSOR</u>	<u>HALL EFFECT MODULE</u>
<u>4 & 6-cylinder system</u>	<u>4 & 6-cylinder system</u>	<u>4-cylinder system</u>
PLASMA Installation Manual	PLASMA Installation Manual	PLASMA Installation Manual
1, 2*: PLASMA Ignition Module	1, 2*: PLASMA Ignition Module	1, 2*: PLASMA Ignition Module
1, 2*: DC Mini Sensor with harness and bracket with hardware	1, 1*: Crank Sensor circuit board and bracket	1, 2*: Hall Effect Sensor Module
1, 1*: Magnet Ring	1, 2*: Sensor Harness	1, 2*: Sensor Wiring Harness
1, 2*: Mag hole cover	2, 4*: Trigger Magnets	1, 2*: Gasket for Hall Effect Sensor Module
2, 4*: Dual output ignition coils with mounting bracket (3, 6* / 6-cyl sys)	1, 2*: Mag hole cover	2, 4*: Dual output ignition coils with mounting bracket
2, 4*: RG400 primary cables and 4, 8* terminals (3, 6* cables and 6, 12* terminals / 6-cyl sys)	2, 4*: Dual output ignition coils with mounting bracket (3, 6* / 6-cyl sys)	2, 4*: RG400 primary cables and 4, 8* terminals
4, 8*: High Tension Ignition Leads (6, 12* / 6-cyl sys)	2, 4*: RG400 primary cables and 4, 8* terminals (3, 6* cables and 6, 12* terminals / 6-cyl sys)	4, 8* High Tension Ignition Leads
4ea, 8ea*: Spark Plugs and Inserts with Gaskets (6ea, 12ea* / 6-cyl sys)	4, 8*: High Tension Ignition Leads (6, 12* / 6-cyl sys)	4ea, 8ea*: Spark Plugs and Inserts with Gaskets
1, 1* or 2*: Tygon Tubing	4ea, 8ea*: Spark Plugs and Inserts with Gaskets (6ea, 12ea* / 6-cyl sys)	1, 1* or 2*: Tygon Tubing
1: Output Connector Kit 1*: Dual Output Connector Kit with Interconnect	1, 1* or 2*: Tygon Tubing	1: Output Connector Kit 1*: Dual Output Connector Kit with Interconnect
	1: Output Connector Kit 1*: Dual Output Connector Kit with Interconnect	

Section 2 SYSTEM INSTALLATION

2.1 PLASMA CDI IGNITION MODULE PLACEMENT

The **PLASMA CDI** module should be mounted in a clean and dry place on the cold side of the firewall. If space limitations require mounting on the engine side of the firewall, a protective metal cover should be used to protect the module from water/engine cleaning materials and heat. Air must be allowed to flow between the bottom of the module and the mounting surface.

On 6-cylinder systems, cooling air can be supplied to the box via the port on the 15-pin connector side of the ignition module. For 6-cyl systems that do not have a cooling port, contact LSE for this modification. (Cooling air is not required on 4-cyl systems.) **6-cylinder PLASMA systems sold before 2008 that have not been upgraded to version -8 or -9 must have cooling air supplied.**

2.2 IGNITION COILS

Ignition coils are typically mounted on the top center of the engine. They can also be mounted on the motor mount tubes using Adel clamps or on the firewall to a piece of angle aluminum. Ignition coils should be mounted so that spark plug lead length will be kept to a minimum for maximum spark energy and minimum noise. It is important that each coil connects to **opposing** cylinders, i.e. one coil fires cylinders 1 and 2 and the other coil fires 3 and 4.



2.3 PRIMARY IGNITION WIRES

Connect the BNC connector to the Plasma box and route the primary ignition wires (RG400 coax) to the ignition coils. Make sure that the BNC connector is fully engaged into the over-center position. Cut the wire to length and connect the center conductor to one ignition coil blade and the shield to the other blade using standard spade terminals. Leave enough length so that, if necessary, the BNC

connector can be switched during the Phasing procedure, Section 5.1.

Polarity at the coils does not matter.

On Plasma III systems, the shield is not a "ground".

* Refer to the PHASING section 5.1, to determine which coil is connected to channel A, B and C (6-cyl.).

2.4 SPARK PLUG ADAPTORS AND SPARK PLUGS

- Aircraft engines using 18mm & $\frac{1}{2}$ " reach spark plugs use adaptors with the same outside thread and a 14mm & $\frac{3}{4}$ " reach inside thread.

Use LSE high performance HP plugs, Denso spark plugs starting with a W or NGK spark plugs starting with a B in their designation.

- Aircraft engines using 18mm & $\frac{7}{8}$ " reach spark plugs use one of the following:
 - LSE long reach adaptors with 12mm inside thread for Denso X27GPR-U or X24GPR-U or equivalent 12mm spark plugs.
 - OR**
 - Optionally, for high performance applications, use LSE HP-LR (long reach) adaptors with 14mm inside thread for high performance HP-LR or IKH 14mm spark plugs.
- Install adaptors in cylinder head using the supplied copper washer. Torque to 35 - 45 ft-lbs using anti-seize compound.
- Install automotive style spark plugs with their washer. Torque to 20 ft-lbs using anti-seize compound.

* WARNING- DO NOT USE SHORT REACH ADAPTERS IN ENGINES THAT USE LONG REACH AIRCRAFT PLUGS OR VICE VERSA.

LSE Spark Plug Gap Specifications

Engines normally timed at 25 degrees BTDC:

These are typically engines with compression ratios less than 8.7:1. Gap spark plugs fired by the CDI to .032", max wear limit is .040".

Engines normally timed at 20 degrees BTDC:

These are usually engines with compression ratios of 8.7:1 or higher. Gap spark plugs fired by the CDI to .026", max wear limit is .035".

Turbo / Supercharged engines:

Gap the spark plugs fired by the CDI to .026", max wear limit is .035".

Turbo Normalized engines:

Gap the spark plugs fired by the CDI according to the compression ratio.

Standard nickel electrode plugs should last 200 – 400 hours depending on use. It may be necessary to re-adjust the electrode gap at every 100 hour inspection.

Iridium spark plugs should last 300 – 600 hours but also need to have the electrode gap checked and possibly re-adjusted at normal inspection periods.

2.5 HIGH TENSION LEADS

The high tension leads supplied in the kit **must** be used with the **PLASMA CDI** systems since the spark energy is far too great to be used with any shielded aircraft leads or high resistance automotive wires. The two high-tension leads from each coil connect to spark plugs on opposite sides of the crankshaft. That means one coil fires cylinders 1 and 2 and the other coil fires 3 and 4. A third ignition coil fires cylinders 5 and 6 on 6-cyl systems.

The spark plug wires supplied in the *PLASMA* CDI System kit are high quality ignition leads designed to transmit spark energy efficiently and to suppress ignition noise. Additionally, it is necessary to use resistor spark plugs, also supplied in the kit, to suppress ignition noise. When these wires and plugs are used, they usually do not need shielding. High-tension leads should be kept as short as possible. ADF and Strikefinder use may call for additional shielding.

2.6 POWER SUPPLY

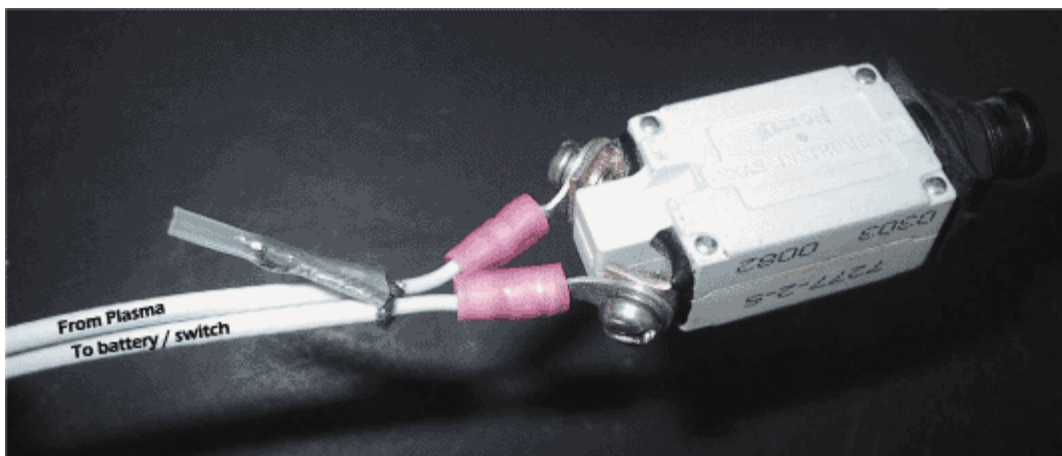

Power Wire Connection. Note Continuation of shield- insulated.

- To connect power to the ignition system, install the 15-pin input connector from your sensor harness to the ignition module. Route the single conductor shielded power lead to a pull-able breaker, 4-cyl systems use 5A and 6-cyl systems use 7.5A, and then directly to the battery plus terminal, bypassing any electrical buss or master solenoid. Refer to the *Input Connector Diagram* & the *Electrical Requirements*.
- The positive 12 or 24 Volt power supply (center conductor) is soldered to pins 7 and 8 of the input connector (at LSE) and is connected to the breaker (and toggle switch if used) per the Power Wire Connection picture, above.
- The shield is used as a ground return (negative supply) and is continued across the breaker (and toggle switch if used) per the Power Wire Connection picture, then connected to the battery negative terminal.

- Power and ground (shield) connection must be directly to the battery terminals to achieve the best reliability, to avoid voltage spikes, and to minimize radio noise.
- If a standard aircraft key switch is used as an on/off switch, see *Note 4* on the *Input Connector Diagram*. Do not install a grounding jumper on the key switch terminal you use for the Plasma CDI.

Note: It is important to locate antennas, receiving or transmitting, away from the engine and ignition systems.

2.7 OPTIONAL ELECTRICAL CONNECTIONS

1. Tachometer

All Plasma CD Ignitions have a standard tach pulse output on Pin-6 (signal) and Pin-13 (return) of the INPUT connector. This tach signal is a 10V pulse that can be read by most electronic tachometers or engine monitors. If your tachometer requires an "open collector" type pulse, the Plasma III system can be configured for that signal output at LSE. Note, some Electronics International and Vision Microsystems instruments may require this modification.

2. Output Connector

Several **optional** features are available on the 15-pin output connector.

Note: If you are using a toggle switch to turn the Plasma CDI on and off, it is not necessary to have any connections to the output connector.

Key Switch Option:

Connecting a single conductor shielded wire to Pin-1 (signal) and Pin-9 (return) allows the use of a standard "left-right-both-start" aircraft key switch. Connect this wire to your key switch as if it was a "P"-Lead from an impulse type magneto. This means there should be no jumper installed if you connect the Plasma CDI "P"-Lead to the "R" terminal of your key switch. Delete the toggle switch in the power supply to the input connector if you are using a key switch.

Note: There is no current drain if the key switch is turned off.

Pin 14:

This pin is a low current 5V supply for the cockpit display, Simpson or similar. Pin-14 is also used to power the ignition indicator lights on dual Plasma CDI installations. Both indicator lights are off when both Plasma ignitions are on. One indicator light is on when either one of the ignition systems is off.

Pins-7, 8, and 15:

These pins enable the "Interconnect" feature used on dual Plasma CDI installations. If used, this interconnection advances the timing of the operating system when one of the systems is turned off or is otherwise disabled. The interconnection has no effect on either ignition when both systems are on.

Pins-5, 6, and 13:

These pins are normally not used and should be left open.

This timing bias feature should only be used for research on special application engines and always in conjunction with a timing display. In this case, a 10k linear potentiometer can be installed per the output connector diagram to bias the existing timing by +/- 5 degrees when the engine is operating at or near the mid-point of its timing range. The potentiometer cannot expand the Plasma CDI 's normal 22 degrees of timing range. For this reason, the timing cannot be retarded further during take-off since the system is already near the minimum timing advance. Similarly, on the advanced end of the timing range, you cannot increase the total advance during a low power descent.

Pins-2, 3, and 4:

These pins are millivolt outputs for RPM, Timing Advance, and Manifold Pressure. Typically, these outputs are used with LSE's prewired Simpson timing display. Alternatively, a handheld mV meter can display these outputs within 0.01" MAP, 0.01 degrees Timing, and 1 RPM resolution, when connected per the output connector diagram. During startup this display would typically read 00.00 degrees timing, at high power conditions it will show approx.. 25 degrees and during low power operations it will show as much as 42 degrees of timing advance.

2.8 MANIFOLD PRESSURE LINE

Connect the manifold pressure line to your Plasma box. If you have a MP gauge in the cockpit, you can tee into that line. An 1/8" ID Tygon tube is recommended. On Lycoming engines, any one of the 1/8" pipe thread ports in the intake can be used as a source for manifold pressure information. Most other engines have a designated port near the carburetor. If the manifold pressure is left open or becomes disconnected, the Plasma CDI will operate safely but with less timing advance.

2.9 GENERAL INSTALLATION INSTRUCTIONS**Electrical System Requirements**

All Plasma CDI systems can be used with 12 or 24-volt electrical systems. Input voltages above 32 volts or reversed polarity can cause system damage if the required 5 Amp (4-cyl.) or 7.5 Amp (6-cyl.) circuit breaker is not installed.

It is mandatory that all aircraft using Plasma CD ignitions are equipped with over-voltage protection in their alternator charging system(s). Over-voltage protection is a requirement for certified aircraft. Power connection must be directly to the **battery terminals** to avoid voltage spikes and electrical noise and for best reliability. Aluminum should never be used as an electrical conductor for the Plasma CDI. Use only the supplied aircraft quality stranded wire.

Minimum supply voltage for starting is 6.5 Volts.

Minimum operating voltage is 5.5 Volts.

For Dual PLASMA CDI Installations, an auxiliary battery and ignition indicator lights are recommended.

[Aux Battery Wiring Diagram, Figure 1](#)

[Dual Ignition Indicator Lights Wiring Diagram, Figure 4](#)

[Plasma CDI Input Connector Diagram, Figure 2](#)

[Plasma CDI Output Connector Diagram, Figure 3](#)

*Do not route the input wires from the sensors (DC Mini Sensor, Hall Effect Module or Direct Crank Sensor) near the output wires (RG-400 primary ignition wires) or the high-tension leads going to the spark plugs. A ½" or greater separation is recommended to avoid electronic interference.

*The RG-400 (coax) primary ignition wires connecting the ignition coils to the Plasma CD module can all be routed together and in close proximity to other high power wires (starter cable, alternator cable...).

The shielded cable from the triggering mechanism is a "sensor" wire; it can be routed together with other low-voltage "sensor" wires. All "sensor" wires should be well separated from high power wires.

*If your mag fires top and bottom plugs, reroute the cables to fire either all on top or all on the bottom spark plugs. The **PLASMA CDI** can fire either the top or the bottom plugs. If you use one magneto, your engine runs a little better with the advanced spark on the top plugs.

*Ensure wiring is securely fastened, especially near the terminals, to avoid damage from vibration.

Section 3 TRIGGER SYSTEM INSTALLATION

3.1 A: DC MINI SENSOR INSTALLATION **Lycoming Installation**



The sensor mounting brackets are designed to attach to the seal retainer bosses on the crankcase. Mount the Mini Sensor Bracket to the crankcase as shown in the following DC Mini Sensor & Mounting Bracket Installation pictures. Align the bracket concentric to the crankshaft by resting the centering tabs of the bracket on the crankshaft. Use the two long alignment tabs if you have a 2-3/8" crankshaft. If you have a 2-5/8" crankshaft, break off the long tabs and rest the short alignment tabs on the larger crank diameter. Visually align the crankcase split line with the V notch on the mounting bracket. With the tabs touching the crankshaft and the V notch aligning with the split of the case, fasten the bracket to the case using the supplied bolts and lock washers. **Once the bracket is mounted to the crankcase, remove any remaining alignment tabs.**

If the mounting bosses on the crankcase are not drilled, use the bracket to locate and mark the hole positions. If possible, use a #2 centering drill for a pilot hole. Drill #6 (0.204) x 5/8" deep. Tap 1/4-20. For best results, use a 3-flute spiral point HSS tap with aluminum tapping fluid such as Tap-Magic.

If your crankshaft has a solid flange (no lightning holes) press the larger drive lug out of the prop flange to gain access to the mounting bosses. On 6-cylinder engines this may not be necessary. The prop bolts align with the mounting locations so you can drill and tap through the drive lugs.

If the Mini Sensor was removed for this operation, re-install it now. On 4-cyl sensors it is important that the cable exits the top mini sensor to the left side of the engine and on the bottom sensor to the right side of the engine.

Route the sensor cable along the crankcase to the firewall while remaining clear of the exhaust system. Drill a 7/8"-1" hole through the firewall to feed the 15-pin connector to the Plasma CDI location. Reseal and fireproof the penetration of the firewall using established practices. Do not modify the sensor wires, they are assembled and tested professionally at LSE!

Sensor gap: The gap between the epoxy face of the mini sensor and the surface of the magnet ring should be **within 0.030" – 0.060"**. The clearance should fall within these parameters with the crankshaft pushed in and pulled out. The stainless mounting bracket provided for Lycoming engines has long slots for sensor to magnet gap adjustment.

Centerline: The vertical center of the Mini Sensor and the V notch on the mounting bracket should align with the split line of the engine case at the top mounting location on all engines. For dual 4-cylinder Plasma installations, a second Mini Sensor is installed 180 degrees from the first sensor. For dual 6-cylinder installations, a second Mini Sensor is installed 120 degrees from the first sensor.

Concentricity: Align the marked horizontal centerline on the sensor face with the machined circle on the magnet ring once the flywheel is installed per section 3.1B.

Use blue Loctite and the proper torque on all fasteners at final installation.

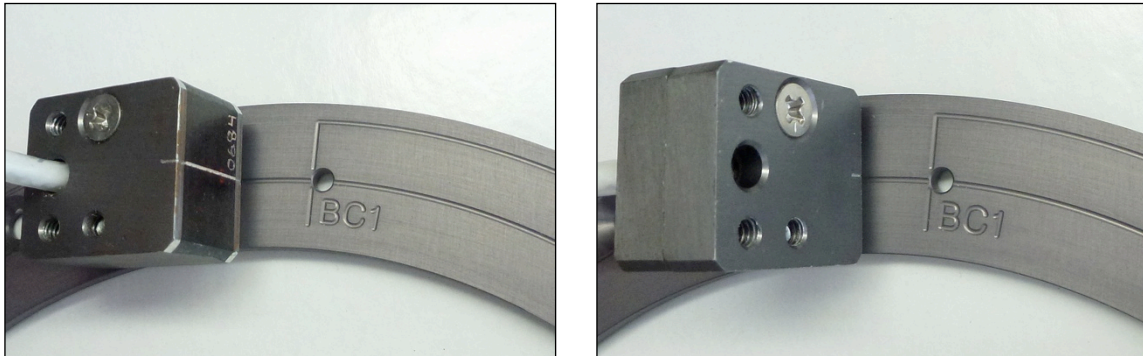

Align the marked centerline on the sensor with the machined circle on the magnet ring.

The magnet ring for 4 cylinder engines comes with 4 magnets installed. Magnet rings for 6 cylinder engines have 6 magnets installed. There is no change to the magnet ring if a second Mini sensor is added for a second Plasma CDI.

Timing:

The leading magnet is installed in the 45-degree location for engines timed at 25 degrees BTDC per the engine data plate. Higher compression engines normally have the magnets installed in the 42 or 39-degree location. Normally the magnets are installed at LSE based on the timing information provided to LSE when the system was ordered. If you are installing your own magnets, be sure to have the South Pole facing the sensors.

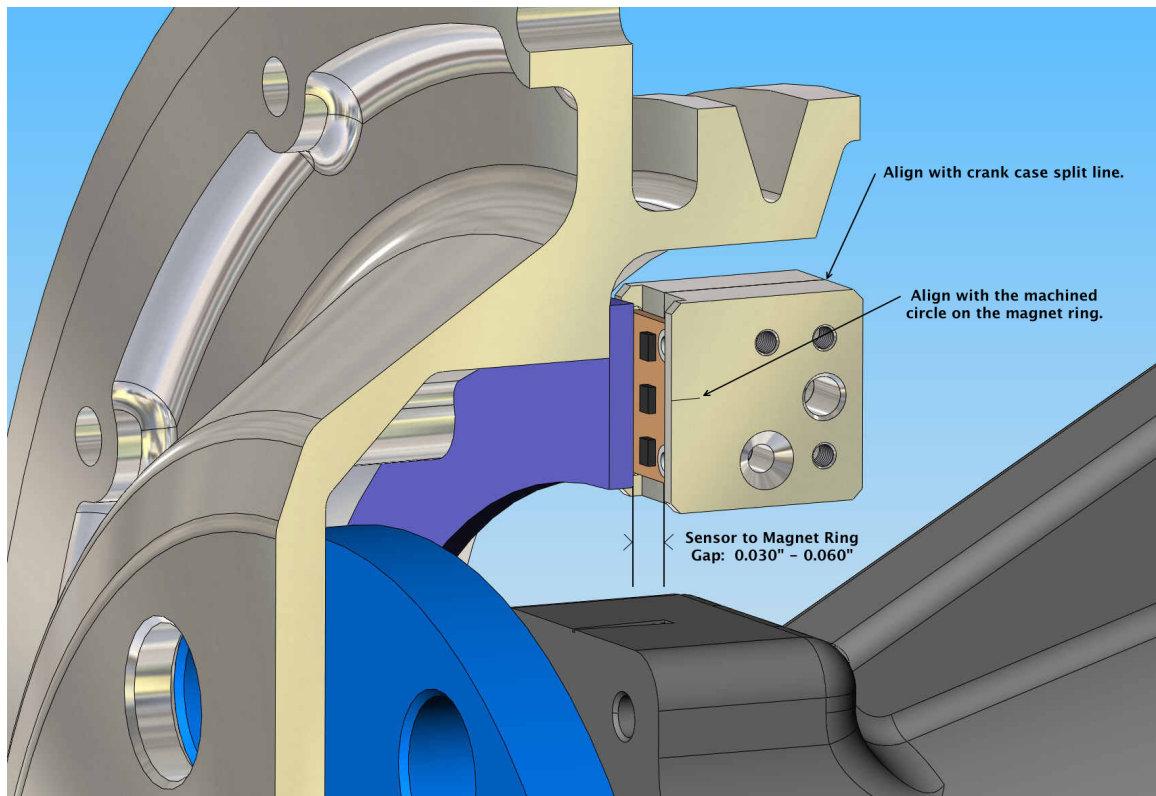

- Check Alignment:
 - Vertical centerline to crank case split line
 - Marked centerline on the sensor face to machined circle on ring
- Check Gap:
 - Sensor to Magnet Ring Gap 0.030" - 0.060"

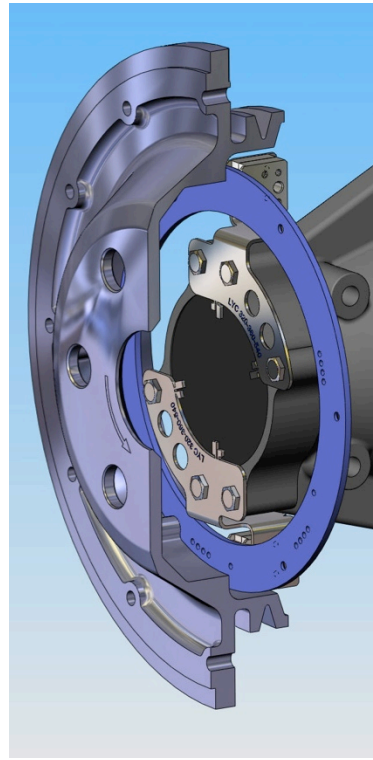
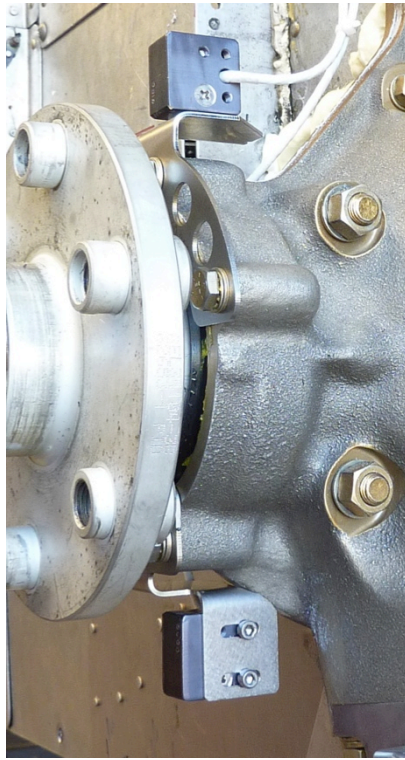

Dual 4-cylinder DC Mini Sensor & Mounting Bracket Installation.
Note Cable Routing.



Dual 6-cylinder
DC Mini Sensor
&
Mounting
Bracket
Installation

*(Shown here without
crankshaft for
demonstration only.)*

3.1 B: DC MINI SENSOR INSTALLATION **Magnet Ring Installation**

Mounting the DC Mini Sensor Magnet Ring to the Lycoming flywheel requires high precision. For this reason, the 6 mounting holes must be located and drilled using a CNC machine. If CNC machining is not available, the flywheel can be sent to Light Speed Engineering for modification and magnet ring installation at \$95 plus shipping. Alternatively, pre-drilled flywheels are available for purchase from ECI and the Lycoming Thunderbolt Division upon request.

Only flywheels with a large diameter alternator pulley and 6 mounting bosses, as shown, can be used with the Mini sensor or the Direct Crank Sensor Circuit Board.

DC Mini Sensor Magnet Ring Installation, Lycoming Type Flywheel

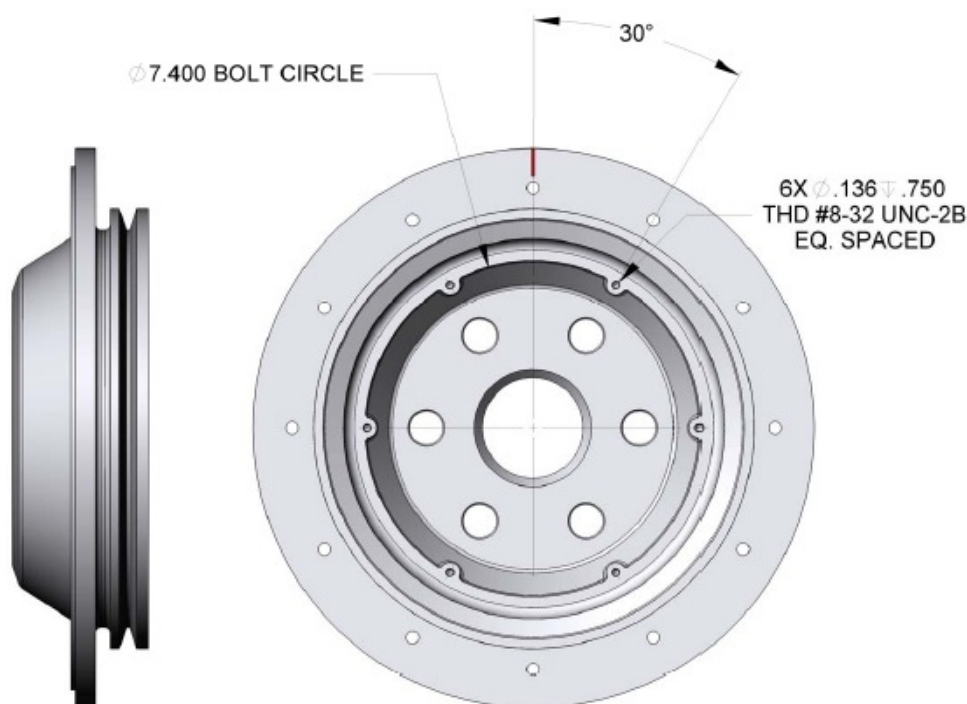

PROPRIETARY AND CONFIDENTIAL THE INFORMATION CONTAINED IN THIS DRAWING IS THE SOLE PROPERTY OF <INSERT COMPANY NAME HERE>. ANY REPRODUCTION IN PART OR AS A WHOLE WITHOUT THE WRITTEN PERMISSION OF <INSERT COMPANY NAME HERE> IS PROHIBITED.		DIMENSIONS ARE IN INCHES TOLERANCES: ANGULAR: ± 1/2 DEGREE TWO PLACE DECIMAL ±.01 THREE PLACE DECIMAL ±.005		NAME JRL	DATE 10/18/09	LIGHTSPEED ENGINEERING
		MATERIAL	DRAWN	CHECKED	ENG APPR.	MFG APPR.
NEXT ASSY	USED ON	FINISH	COMMENTS:			
APPLICATION	DO NOT SCALE DRAWING					

Proceed to Section 4 for Magneto Removal & Cover Plate Instructions.

3.1 C: DC MINI SENSOR INSTALLATION **Continental, Franklin, and Other Engines**

These engines use the same Mini Sensor technology as the Lycoming engines but with different sensor mounting brackets and magnet carriers.

Mount the Stainless Steel Magnet Ring Brackets to the aft face of the propeller flange. Mount the Magnet Ring using only Stainless Steel flush screws (supplied). Clock the Magnet Ring to have the TC1 mark at the top Mini Sensor when cylinder 1 is at TDC. On dual 6-cyl Mini Sensor installations, a second Mini Sensor is installed 120 degrees from the top Mini Sensor.

The vertical split-line of the top Mini Sensor must be in line with the split line of the crankcase. The sensor to magnet ring gap must be within 0.030" – 0.060" with the prop pushed in and pulled out. The horizontal line on the sensor face must align with the center magnet sequence on the magnet ring (the center of the 120° magnet).

See the pictures below.

DCmini Sensor for Continental and Franklin 6- Cylinder Engines:

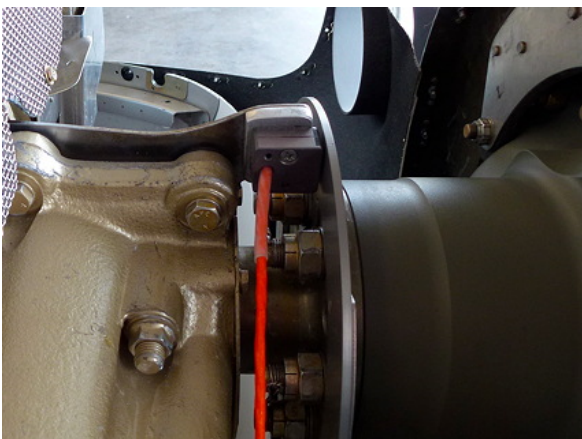
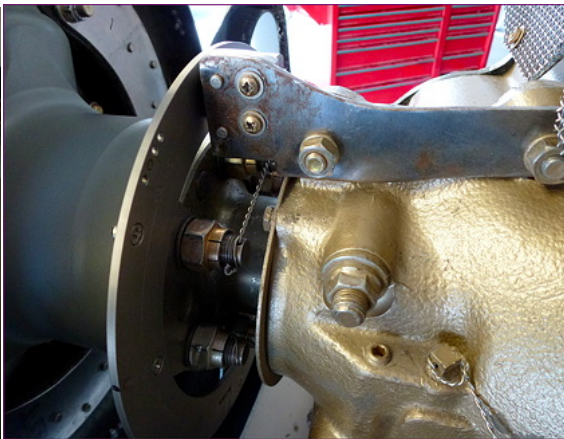
	<p>DC Mini Sensor Magnet Ring for Continental 6-cyl. Engines</p>
	
<p>Single DC Mini Sensor with Mounting bracket installed in the top position on a Continental TIO-550 engine.</p>	

DC Mini Sensor for Continental O-200 4-Cylinder Engines:

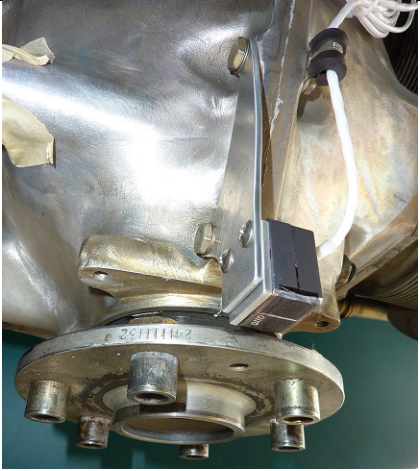
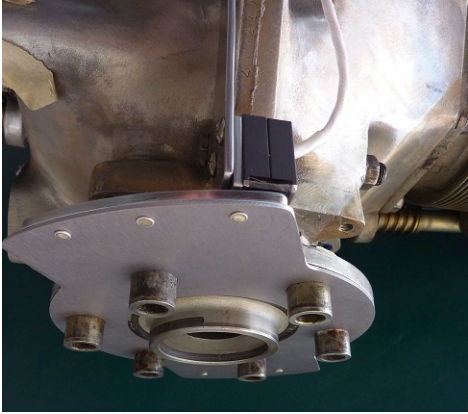
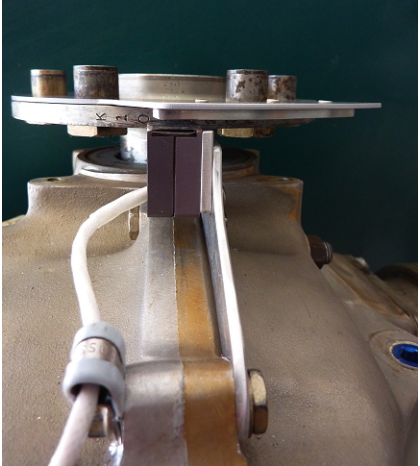
	<p>Continental O-200 Mini Sensor installation on the top of the engine. The trigger magnet plate is not installed in this picture in order to provide a clear view of the mini sensor mounting bracket.</p>
	<p>Top Mini Sensor on O-200 with the Trigger Magnet plate installed. Note: Cable exits the mini sensor in a clockwise direction for both the top and the bottom sensor.</p>
	<p>Mini Sensor installed on the bottom of the Continental O-200 to provide the trigger for the second system in a Dual Plasma CDI installation. On Dual 4-cylinder installations, there are two mini sensors installed at 180 degree intervals.</p> <p>Note the alignment of the mini sensor vertical centerline with the crankcase split line.</p>

Timing: The trigger magnet plate is custom made for your application. The magnets were installed to result in the correct timing as specified when the Plasma CDI system was ordered. In the direction of normal rotation, the second magnet is across from the center of the sensor when the engine is at TDC. The first magnet is across from the sensor when the engine is at the data plate timing plus 20 degrees. For example: If you have 9.4:1 CR, max power timing should be 22 degrees BTDC so the leading magnet should be at 42 degrees before the TDC magnet.

Proceed to Section 4 for Magneto Removal & Cover Plate Instructions.

3.2 HALL EFFECT SENSOR MODULE **INSTALLATION** **Available for 4-cyl. Lycoming Type** **Engines Only**

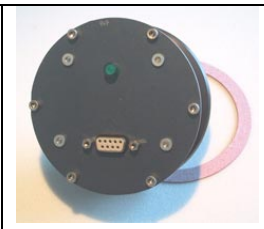

To install the accessory case driven Hall Effect Sensor Module, please follow these instructions:

Remove the magneto.

Install a magneto drive gear from a non-impulse magneto onto the shaft of the sensor module using the same woodruff key as well as the LSE supplied washer and locknut.

Fasten the gear in a soft jaw vise and tighten the nut to 45 ft-lb ensuring that the washer is centered on the shaft.

The module can be installed on either mag pad using standard clamps. If the Hall Effect Module is installed in place of the impulse-coupling magneto, remove the spacer for the impulse coupling and replace the long studs with short ones.

Leave the toe clamps loose for the final timing adjustment.

Remove one sparkplug from each cylinder and turn the crankshaft to TDC #1 using the factory timing marks on the engine side of the flywheel.

Connect the 9-pin connector to the Hall Effect Module and secure.

Turn electrical power on and rotate the sensor module in the accessory case **counter-clockwise** until the **green light on the module case turns on and then off again**. Maintaining its position, fasten the sensor module with the toe clamps commonly used with Slick Magnetos.

This procedure positions the Hall Effect Module for engines normally timed at 25 degrees Before TDC (usually standard compression ratio).

If your engine is normally timed at 20 degrees Before TDC (usually compression ratios of 8.7:1 or higher), the timing must be retarded 5 degrees. In this case, position the crankshaft to 5 degrees past TDC in the direction of rotation and use the procedure outlined above.

**PROCEED TO SECTION 5 TO PERFORM OPERATIONAL TESTING
 TO ENSURE THE UNIT IS INSTALLED CORRECTLY.**

3.3 A: DIRECT CRANK SENSOR CIRCUIT BOARD INSTALLATION **Lycoming Installation**

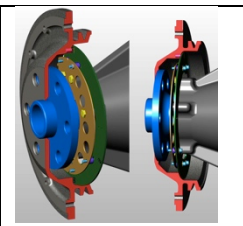

The crank sensor circuit board has two completely independent triggering systems if it is used for dual Plasma CDI applications. On single installations only the outer set of sensors and associated wiring is installed.

Remove the flywheel to install the magnets and the crank sensor assembly. The outer trigger magnets are installed in the flywheel on a **4.000" radius**. The inner trigger magnets, used for a second system, are installed on a **3.840" radius** (refer to the picture below). You may wish to send your flywheel to LSE for installation of the magnets and the timing marks; cost is \$50 plus shipping; plan on 1 day plus shipping time.

Please refer to the attached pictures and those on the Crank Sensor page of the web site (www.LightSpeedEngineering.com) to mount the sensor plate to your crankcase and integrate the trigger magnets into your flywheel. Use a number 32 drill, 1/8" deep so that the magnets can be pressed in flush with the surface. Use Loctite and stake around them. Two or four magnets are included. Single systems require only two magnets on the 4" radius. Looking into the pulley side of the flywheel, the left magnet position should always line up with the TDC indication under the starter ring gear. For the other magnet position, add 20 degrees to the recommended timing for your engine and install it on the same radius to the right of the first magnet. On engines that should have their magnetos timed at 25 degrees, the leading magnet should be installed at 45 deg BTDC and thereby 45 degrees to the right of the TDC magnet. High compression engines should have their leading magnets installed 40 degrees BTDC. Only the magnet's south pole can trigger the sensors. This is the face marked with an X and therefore, should point to the sensor. In other words, the X must be visible after installation. If the X is not clearly visible, use a compass to identify the correct polarity.



Large diameter alternator pulley required (8.5" ID).

If you have seal retainer plates installed, remove them and use existing holes to mount the bracket. You might have to adjust the holes in the bracket using a dremmel to

make them align with the existing holes. If the bosses are not drilled, use the mounting plate as a drill template as follows.



Align plate concentric to crankshaft by registering on centering tabs. Visually align the crankcase split line with the v notches between the top and bottom 2 holes of the mounting plate. Mark the crankcase mounting locations through the existing holes in the bracket. If possible, use a #2 centering drill for a pilot hole. Drill #6 (0.204) x 5/8" deep. Tap 1/4-20. For best results, use a 3-flute spiral point HSS tap with aluminum tapping fluid such as Tap-Magic. Once the bracket is mounted to the crankcase, remove the three alignment tabs then remove the two control tabs. This sequence allows you to later verify that the alignment tabs were removed. If the circuit board was removed for this operation, re-install it. All screws holding the crank sensor circuit board to the mounting bracket must be secured with Loctite and the proper torque. The 0 degree mark on the circuit

board should now align with the split line in the crankcase when the screws are fastened in the center of their positioning slot.

Now that the sensor plate is installed, perform a simple operational check: Disconnect all high-tension leads from the ignition coils. With power to the system on and the 15-pin input connector installed, take any magnet and swipe it back and forth past each sensor (speed is important, > 2x per second). Every other pass should produce a loud spark at the coil. Only the South Pole works. Check each sensor.

Lycoming external engine dimensions can vary significantly, so you need to verify the proper clearance between the sensor and the magnets installed in the flywheel surface. Two measurements need to be compared to determine the gap.



- First, measure the height from the inside of the flywheel where it touches the crankshaft flange to the surface that has the magnets installed.
- Then, measure from the face of the crankshaft flange back to the sensor face on the circuit board. This second dimension needs to be larger by .030"- .060". The clearance should fall within these parameters with the **crankshaft pushed in and pulled out**.



Too little gap and a flexing crankshaft might touch the sensors.

Too much gap will not trigger the sensors.

Adjust by adding washers to the circuit board spacers (adding clearance) or by adding washers underneath the bracket attachments (subtracting clearance).

3.3 B: DIRECT CRANK SENSOR CIRCUIT BOARD INSTALLATION **CONTINENTAL 550 and FRANKLIN ENGINES**

The following instructions are written for 6-cyl. Continental Engines, but 4-cylinder Continentals follow a similar procedure and may use this as a guide. Additional instructions for 4-cyl Continental Engines can be found in the next section, 3.3-C.

The DC mounting bracket supplied by Light Speed Engineering is common for both the large 6-cylinder Continental and the Franklin engines. Two sets of mounting holes are provided using the same pattern as the crankshaft main seal retainer plates on these engines. The mounting bracket bolts directly to the front of the crankcase in place of the seal retainer and also acts as a seal retainer.

Two sets of centering tabs are part of the bracket and are to center the bracket on the two different crankshaft diameters. If you are using a Continental engine, remove the larger three tabs. It may be necessary to modify the mounting holes slightly to be able to bolt the bracket to the crankcase while all three alignment tabs are touching the crankshaft.

After the bracket is secured using the proper torque, remove all centering tabs then remove the control tab. This allows for easy verification later that the alignment tabs have been removed and are not rubbing on the crankshaft.

Now the circuit board can be installed with its 6 mounting screws and spacers. Apply blue Loctite, visually align the 0 degree arrow on the circuit board with the crankcase split line, and torque the screws to 12 in-lbs.

The magnet holder is mounted under two of the prop fasteners such that the second magnet set (in the direction of rotation) aligns with TDC crankshaft position. When the crankshaft is in the TDC position for cylinders 1 & 2, this second set of magnets is then directly opposite the top Hall Effect sensors (labeled 0 degrees) on the circuit board. The gap between the sensor surface and magnet holder surface must be 0.030" – 0.060". Shim the circuit board with number 8 washers to achieve this clearance when the crankshaft is full forward and all the way back. Remember to check that the gap does not exceed 0.060" between the magnet holder surface and the Hall effect sensors at each sensor location.

The steel counter weight is mounted directly opposite the magnet holder using the same technique. See the Continental Direct Crank Sensor installation picture for reference.

Torque the prop bolts to factory spec.

3.3 C: DIRECT CRANK SENSOR CIRCUIT BOARD INSTALLATION CONTINENTAL O-200 ENGINES

Step 1: The Continental O-200 has 4 mounting bosses on the front of the engine. If they are drilled, the mounting holes in the LSE supplied O-200 bracket should match the bolt pattern on the engine. (If your crankcase is drilled, go to step 5. Otherwise, proceed to step 2.)

Step 2: The dimensions for the factory hole pattern are shown in the Continental engine overhaul manual. If the case is not drilled, it is not possible to get to the factory locations without removing the crankshaft (which is not an option). New holes have to be drilled slightly inboard of the factory locations.

The case has some "draft" in the casting so the forward face of the bosses in question first need to be filed flat and parallel to the flange. This takes about an hour of filing if you have sharp files. Protect the main seal from the shavings by masking. Start with a Vixen file and measure frequently using the mounting bracket as a flat reference.

Step 3: Press out one of the drive-lugs from the flange by using a socket and a bolt. If it is hard to get out, a little heat might help. Don't use a hammer!

Step 4: Once the drive-lug is removed, you have enough access to reach the bosses on the case for drilling and tapping. Hold the mounting bracket concentric to the crankshaft to drill through the bracket and into one of the bosses.

Use a number 6 drill, $\frac{3}{4}$ deep. Tap this first hole using a $\frac{1}{4}$ -20 tap and hold up the steel bracket as concentric as possible. Adjust the hole as necessary when you enlarge it for the $\frac{1}{4}$ " bolt size. Bolt the bracket down to hold it in place while you drill the other three No. 6 holes. Remove the bracket and tap all. Now open up the holes in the bracket to accept all 4 bolts holding the bracket parallel and concentric to the crankshaft flange.

Step 5: On final installation of the mounting bracket, use blue Loctite and/or safety wire to secure the bolts. Install the bracket per picture #1, with the slots lining up with the split line of the case and as concentric to the crankshaft as possible.

Step 6: Now the circuit board can be installed with it's 6 mounting screws and 0.87" spacers. Use blue Loctite and 12 in-lbs of torque. Visually align the 0 degree arrow on the circuit board with the crankcase split line. (Picture 2)

Step 7: Install the trigger magnet plate between the propeller extension and the propeller flange. Confirm the magnets are pointing towards the engine. Clock the magnet plate to have the second magnet passing the top sensor location (labeled 0) on the circuit board when the crankshaft is at cylinders 1 & 2 TDC. (Picture 3)

Step 8: Measure the gap between the magnet plate and the copper face of the direct crank sensor board. Make adjustments by uniformly shimming all 6 spacers. If the spacers are too long, use a lathe to shorten all of them by an even amount. Do not make any custom spacers or the board will warp when tightened down. Contact Light Speed Engineering if you need help with this.

If you are using 1/8" diameter magnets, the gap should be between 0.030" and 0.060" with the crankshaft pushed in and pulled out. There usually is about a 0.010" endplay. If you have 1/4" diameter magnets, the gap can be as much as 0.1".

When installing your propeller extension, be sure you have at least 6 threads of your bolts engaging with the drive lugs.

Timing: The magnet plate is custom made for your application. The magnets were installed to result in the correct timing as specified when the Plasma CDI system was ordered. In the direction of normal rotation, the second magnet is across from the center of the sensor when the engine is at TDC. The first magnet is across from the sensor when the engine is at the data plate timing plus 20 degrees. For example: If you have 9.4:1 CR, max power timing should be 22 degrees BTDC so the leading magnet should be at 42 degrees before the TDC magnet.

**C. CONTINENTAL O-200 ENGINES - continued....
DC CIRCUIT BOARD INSTALLATION**



Picture 1:

Mounting
Bracket
Installed
Concentric
and
Clocked

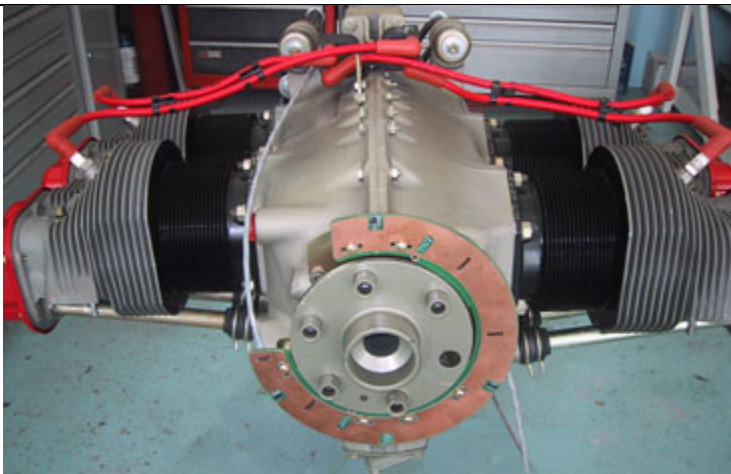

Picture 2:

Direct Crank
Sensor Circuit
Board
Attached to
Crankcase
Mounting
Bracket

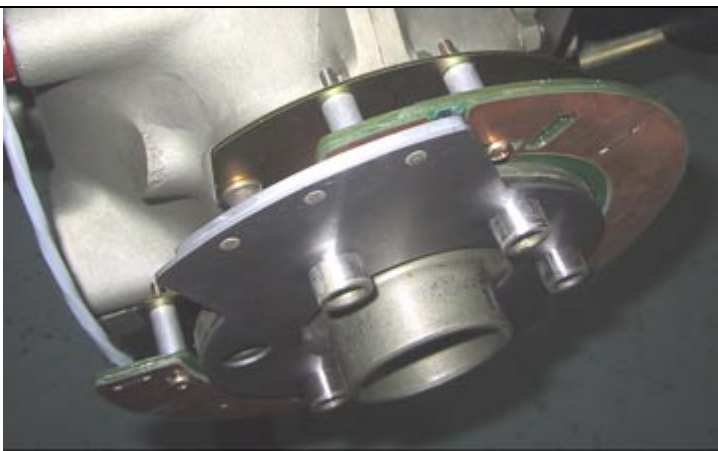

Picture 3:

Magnet to
Sensor
Gap.

TDC
Magnets
at
TDC
Sensor.

Section 4 MAGNETO REMOVAL and COVER PLATE INSTALLATION

When removing the magneto(s) be sure to remove the magneto with its drive gear. 6-cylinder magnetos and single drive dual magnetos typically have pilot bearings that **need to be removed**.

Continental 6-cyl. Engine Magneto Removal Notes:

On the 6-cylinder Continental engines, each magneto shares a common gear with the opposing vacuum pump / standby alternator drive.

Single Mag / Single Plasma Use: If one magneto is retained for use with a Plasma CDI, the vacuum pump pad opposed to this magneto can be used for a pump or alternator. Subsequently, the other drive should be disabled by removing the magneto and associated gear assembly. Seal both the vacant vacuum pump pad and magneto pad using cover plates.

Dual Plasma Use: If two Plasma CDI systems are used, both magnetos and their drive gear assemblies are removed. This disables the vacuum pump pads. If it is necessary to drive a vacuum pump, a magneto and the drive gear assembly can be used to enable this drive. The points should be removed to disable the magneto. Other parts, such as the ignition coil, can be removed from the mag to save weight and drag.

Alternatively, a starter drive with a pulley for air conditioning is available from Continental. This pulley can also be used to drive a rear alternator.

* **IMPORTANT!** Over-voltage protection must be provided with any electrical system.

Cover Plate Installation:

Install the magneto hole cover plate provided by LSE in place of the magneto. Use only liquid sealant and the magneto "toe clamps" to secure this plate. Gaskets are not recommended as they may distort the cover plate.

Section 5 OPERATIONAL TESTING

5.1 PHASING (CYLINDER FIRING ORDER) – IMPORTANT!

Since we have not specified wire tracing and valve position, which define the difference between compression stroke and exhaust stroke, on 4-cylinder engines, there is a 50% chance that the timing will be 180° out of phase.

With all spark plug wires removed from the coils and one sparkplug removed from each cylinder, turn your ignition on and rock the propeller back and forth near cylinder 1 TDC. A spark should jump between the output terminals of one ignition coil. The high-tension leads from this coil must be connected to cylinders 1 & 2.

On 4-cyl engines, repeat this procedure 180° out and confirm firing of the second coil, then connect the high-tension leads from this coil to cylinders 3 & 4.

On 6-cyl engines, repeat the above 120° out, for example: when cylinders 5 & 6 are at TDC. The coil that sparks must be connected to the opposing cylinders that have their pistons at TDC – in this case, cylinders 5 & 6. Repeat the same for cylinders 3 & 4. Refer to the engine firing order when assigning the second and third coil.

You can change phasing by switching BNC connectors at the Plasma Ignition module.

Once the ignition is phased correctly, mark all coils and wires for their proper assignment.

Re-install spark plugs per section 2.4, ensure all spark plug wires have been tightly re-connected and you are ready to start your engine.

The engine may now be running extremely well, smooth and quiet. However, **DO NOT FLY UNTIL THE REST OF THE OPERATIONAL TESTS ARE COMPLETED.**

Due to the performance increase, the engine now idles 50-150 RPM higher than before. Reduce idle to normal by adjusting the carburetor or fuel injection system. Re-adjust the idle mixture using standard procedures.

Lycoming 320 engines should idle at 0.6 – 0.8 gph.

Lycoming 360 engines should idle at 0.8 – 1.0 gph.

Lycoming 540 engines should idle at 1.4 – 1.8 gph.



After Engine Warm-up.

5.2 IGNITION TIMING

The Plasma CD Ignition spark timing is a result of the built in timing curve and the installation of the triggering magnets relative to the Hall effect sensors of each sensor system.

The engine timing advance can be displayed in the cockpit using the optional timing display from LSE or any digital mV meter connected to pins 3 and 11 of the output connector. I.e. 0.025V = 25 degrees BTDC. On DC Mini Sensor installations, the timing display will show the actual timing advance. On other sensor installations, the displayed timing information may need to be corrected if the sensor board is not mounted in the center of the mounting slots or, in the case of the Hall Effect Module, if it is not set for 25 degree timed engines.

Note:

DC Mini Sensor: If you are using the Mini Sensor with bracket and magnet ring supplied by LSE, the timing is set by the leading magnet location. The leading magnet is typically installed in the 45 degrees BTDC location, which will result in 25 degree spark timing at max power. The magnet ring has optional magnet locations at 48 degrees, 42 degrees, and 39 degrees, that are used for engines that should be timed at 28 degrees, 22 degrees, or 19 degrees at max power. The trailing magnet is used for starting and as TDC reference for the timing display.

DC Circuit Board: If you are using a Direct Crank Sensor Circuit Board, the timing is defined by the position of the leading magnet installed in the flywheel and the position in which the circuit board is secured to its mounting bracket. For the proper initial timing, the circuit board is fastened in the middle of its adjustment slot. The DC circuit board can be rotated +/- 5 degrees for fine-tuning your engine.

It is important to note that when using a timing display, the displayed timing value is correct if the 0 degree pointer on the circuit board points to the split line of the crank case. If you rotate the circuit board 5 degrees against the direction of engine rotation, the timing will be advanced 5 degrees. Add 5 degrees to your timing indication. Mark the correction on your display, i.e. -5 degrees.

Hall Effect Module: The above statement also applies to the Hall Effect Module. Rotating the Hall Effect Module will change the actual timing of the engine but the remote indication will not change since the TDC reference is also rotated. If your crankshaft was not at TDC when you set your Hall Effect Module in Section 3.2, make a note on your display, i.e. -5 degrees.

LSE Timing Values for Plasma CDI

Engines Normally Timed at 25 degrees BTDC

(Leading Magnet Installed At 45 degrees Before TDC):

These are usually engines with compression ratios less than 8.7:1.

- At idle the timing display should indicate $40^{\circ} \pm 2^{\circ}$ when the manifold pressure hose is connected and $21^{\circ} \pm 2^{\circ}$ when disconnected.

See Note * below.

Engines Normally Timed at 20 degrees BTDC,

Including Turbo Normalized Engines

(Leading Magnet Installed At 40 degrees Before TDC):

These are usually engines with compression ratios of 8.7:1 or higher.

The timing is retarded 5 degrees.

- At idle the timing display should indicate $35^{\circ} \pm 2^{\circ}$ when the manifold pressure hose is connected and $16^{\circ} \pm 2^{\circ}$ when disconnected.

See Note * below.

If you timed a Hall Effect Sensor Module when the crankshaft was at 5 degrees After TDC to accommodate high compression pistons, the display will not reflect the 5-degree retard!

Turbo and Super-Charged engines:

(Leading Magnet Installed At 40 degrees Before TDC):

- At idle the timing display should indicate $35^{\circ} \pm 2^{\circ}$ when the manifold pressure hose is connected and $24^{\circ} \pm 2^{\circ}$ when disconnected.

See Note * below.

***Note that these numbers are for sea level. You can add 1 degree for each 1,000 ft. of density altitude. The low number (MAP hose disconnected) is the most important! When the hose is connected the timing depends on the MAP. Smoother running engines have more vacuum and that yields more timing advance.**

5.3 ELECTRICAL OPERATING INSTRUCTIONS

No operational limits or special procedures are necessary during normal use. You can either hand start your engine or use your electrical starter. All Plasma CDI systems retard timing to TDC during start and advance timing optimally for all flight conditions based on manifold pressure and rpm.

- In case of a charging system failure, it is recommended that you land at the nearest safe airport and repair the charging system before further flight.
- If you are using Dual Plasma CD Ignition, you can turn one system off, together with all other electrical loads not essential for flight, to maximize your range with your remaining battery capacity.
- Dual Systems only: If you have installed an aux battery per the LSE supplied drawing, monitor your voltmeter and do not switch to the aux battery until the supply voltage of the main battery is below 6.5 Volts or the engine is not running smoothly. After switching to the aux battery, your voltmeter will read the voltage remaining in your aux battery.
- Do not switch your main alternator breaker in flight to avoid potentially damaging voltage spikes. This does not apply to the alternator field breaker.

THIS INFORMATION SHOULD BE CONTAINED IN THE AIRCRAFT OPERATING MANUAL.

YOU ARE NOW READY TO FLY!

HOWEVER, FIRST READ THE REMAINDER OF THIS MANUAL, SO THAT YOU HAVE A THOROUGH UNDERSTANDING OF YOUR LSE *PLASMA* CDI SYSTEM.

5.4 RUN UP TESTS

NOTE:

Due to the significantly higher performance of the LSE **PLASMA CDI** System, it cannot be compared to magnetos during run up in a conventional manner.

If fuel mixture setting is near optimum, there will be no significant RPM drop when the mag is turned off and the engine runs on the **PLASMA CDI** alone.

A large RPM drop, 100 – 200 RPM, will be noticed when the electronic ignition is turned off.

No significant drop is noticed if two Plasma systems are used and the interconnect feature is installed.

Timing Advance Test:

When the engine is at idle, carefully remove the manifold pressure connection at the engine or at the Plasma CDI. You should observe a significant change in sound and a drop in rpm. This confirms that the timing change based on MAP is working. If you are using a remote timing indicator, you should see the timing retard to maximum retard, about 2 degrees less than Data Plate Timing (if you are near sea level). Reconnect your manifold pressure line after this test.

5.5 IN-FLIGHT TESTS

For normal operation, always turn on both the magneto and **PLASMA CD** systems, even if the benefit of the magneto is not noticeable. If you have sensitive EGT information you may notice a lower EGT when both spark plugs are firing. Verify that all cylinder head temperatures are within normal limits. Too much timing advance might cause high CHT's.

Once at a safe altitude, make sure that your engine runs well on each ignition source alone. This assures that, should you have one ignition source fail, you have a good working backup.

Section 6 INSPECTION & MAINTENANCE PROCEDURES

Annual / 100 hour Inspection

All Systems:

Remove spark plugs and check for wear and arcing. Replace spark plugs or re-gap per installation instructions. Clean all signs of arcing using a clean cloth with MEK, acetone or rubbing alcohol. Cleaning spark plugs is not normally needed. Do not bead blast the ceramic insulator. If fouled and wet, use a propane torch to burn off all moisture. Remove dry deposits using compressed air or a sharp steel tool.

Inspect all wiring of the ignition system for wear and chaffing.

Inspect all connections.

Accessory Case driven Hall Effect Module systems:

Remove the Hall Effect Sensor Module cover plate and inspect for oil leakage and bearing wear. There should be no radial play of the shaft when moving the rotor.

500 hour Inspection

All Systems:

Replace high-tension leads at 500 hours or 10-year intervals.

Engine TBO

All Systems:

Replace ignition coils. ***Refer to Coil Reliability.*

Accessory Case driven Hall Effect Module systems:

Replace Hall Effect Module.

Non-Scheduled Inspections

Occasionally Light Speed Engineering issues service bulletins or service instructions. Refer to the LSE Website at www.LightSpeedEngineering.com for information.

****Coil Reliability**

The coils supplied with the Plasma CDI are miniature high performance coils made with a wind ratio specific to the Light Speed Engineering Plasma CD ignitions. In normal use they should be replaced at Engine TBO.

The following installation issues and operating conditions can cause these coils to fail prematurely.

Excessive heat exposure:

Maximum continuous operating temperature is 160 F. This means that they should not be installed inside a cooling plenum box since they can get very hot there when taxiing down wind.

Excessive output resistance:

If one of your spark plug wires is not installed all the way and it vibrates off of the coil or the spark plug, the resistance goes to infinity and the coil will eventually break down internally.

Other factors that increase the resistance are:

- Wrong or broken spark plug wires. Note that the maximum spark plug wire resistance is 800 Ohms/ ft.
- Increased spark plug resistance: The Denso plugs supplied with your system have a high quality 5k resistor built in. Lower quality plugs can burn out their resistor causing the coil to fail. Use only Denso spark plugs for best performance and reliability.
- Worn spark plug gaps: The longer spark required to jump a bigger gap requires a higher voltage. For this reason it is important to maintain the plug gap. Precious metal spark plug electrodes do not wear as fast as nickel electrodes. The spark plugs should be replaced or re-gapped at 100-hour inspection intervals.
- High compression ratio: The Plasma CDI system has been flight tested in many high compression race engines with great success. The increased combustion pressure does increase the stress on the coils. For Turbo / Super charged engines using more than 45" of manifold pressure we recommend using the much larger "GM" style ignition coils. The cost is the same; they weigh 16 oz. each versus 6 oz. each for the small LSE coils. The "GM" style coils must be mounted on the firewall due to their size.

Section 7 TROUBLESHOOTING

One of the first priorities in designing the LSE **PLASMA CDI** System was its reliability. State-of-the-art circuitry is used throughout combined with professional design. It is unlikely that failures will occur during normal operation.

This is unlike the conventional magneto systems where failures are predictable. Also, contrary to magneto or other distributor systems, there is no wear, timing drift or other loss in performance over time. In short, it either works or does not.

IF SYSTEM FAILURE DOES OCCUR:

All components supplied with the PLASMA CD system have been carefully tested. If any of these components are substituted, optimum performance cannot be guaranteed and such changes might affect the warranty. If deviations from the instructions or supplied materials have been made, please correct those changes before contacting LSE with any problems.

Consult the wiring diagram and assure proper connection of signal wires and power supply.

LSE recommends high-tension lead replacement every 500 hours or every ten years whichever comes first, independent of the ignition source.

Ignition Output Test:

On all systems, remove all spark plug wires from all ignition coils and rock the propeller back and forth at TDC to generate a spark between the coil towers.

Using an Ohmmeter, the primary ignition wires should be open between the shield and the center conductor and about 1 ohm when it is connected to the coil. Measuring from each spade terminal to each output terminal of the coil should show an open circuit. Any conductivity here indicates a failed coil.

Verify the integrity of the input wire harness (running from the triggering mechanism to the Plasma CD box) and that it is routed with at least a 1/2" separation from the output wires (RG400 primary ignition wires running from the Plasma CD module to the ignition coils). These wires must be routed through different holes in the firewall in order to maintain a 1/2" or greater separation.

Ignition Input Signal Test:

On all Plasma II and III systems, Input Connector pins 4 and 5 are 5V supply for the Hall Effect Sensors. Verify 5V is present on pins 4 and 5.

Pins 1, 2, and 3(6-cyl) are inputs for channel A, B and C(6-cyl) respectively. With one spark plug removed from each cylinder, verify there is 5V at the input pins on the 15-pin connector that drops to about 0.1V twice per revolution of the propeller when the triggering magnet is switching the Hall Effect sensor. If these pulses are missing, verify the sensor to magnet gap is between 0.030" – 0.060" with the crankshaft pushed in and pulled out. If the input signal does not drop from 5V to near 0V when the South Pole of a magnet is present at the sensor, the input cable or sensor is defective.

7.1 STARTING PROBLEMS

If your battery can no longer crank your engine over, you can hand start your engine using proper safe procedures pulling the prop from at least 50 degrees BTDC. DO NOT ROCK THE PROP BACK AND FORTH. The LSE *PLASMA* CDI system will provide an accurate spark every compression stroke on 4 or 6 cylinder engines as long as the battery has more than 8 Volts.

Do not attempt to hand prop your engine with your non-impulse magneto hot.

If the engine backfires it is also possible that the impulse coupling of the remaining mag is not engaging properly. Any backfiring into the intake side contaminates the intake manifold and starting will be more difficult until fresh air is available. Turn the mag off during engine start if it causes a problem.

7.2 Radio Noise

The Plasma CDI systems are designed to not interfere with any aircraft radios when installed per the manual. If noise is noticed on the radio, it is an indication of arcing on the high voltage lines. This can be anywhere between the BNC connectors and the spark plugs.

Powering the system from your avionics buss will also cause noise. Both power and ground should come directly from the battery terminals.

If you experience radio static that disappears when you turn the Plasma CD electronic ignition system off, check the following possible sources and make any necessary corrections.

1. If you are using Denso ESR-U or ESR-V sparkplugs, check the security of the ferules on the spark plug electrical connection. These plugs have threaded ferules that must be tightened securely.
 2. Examine the high-tension lead connection to both the coils and the spark plugs and confirm they are secured tightly to the metal connector clip inside the boot.
 3. Check the BNC connection at the ignition box for signs of arcing.
-

7.3: TIMING TEST USING A STROBE LIGHT

To verify proper operation of the ignition system, you can check ignition timing using a strobe light, automotive style, both on your new ignition and, should you still have one, on the magneto. The magneto timing should be set to the manufacturers specs.

LSE Timing Values for Plasma CDI:

Engines Normally Timed at 25 degrees BTDC:

These are usually engines with compression ratios less than 8.7:1.

At idle the strobe light should indicate $40^{\circ} \pm 2^{\circ}$ when the manifold pressure hose is connected and $21^{\circ} \pm 2^{\circ}$ when disconnected.

Engines Normally Timed at 20 degrees BTDC, Including Turbo Normalized Engines:

These are usually engines with compression ratios of 8.7:1 or higher.

The timing is retarded another 5 degrees. This setting should show idle strobe light readings of $35^{\circ} \pm 2^{\circ}$ when the manifold pressure hose is connected and $16^{\circ} \pm 2^{\circ}$ when disconnected.

Turbo and Super-Charged engines:

At idle the engine timing should be $35^{\circ} \pm 2^{\circ}$ when the manifold pressure hose is connected and $24^{\circ} \pm 2^{\circ}$ when disconnected. The leading magnet(s) should be installed 40° BTDC.

Note that these numbers are for sea level. You can add 1 degree for each 1,000 ft. of density altitude. The low number (MAP hose disconnected) is the most important! When the hose is connected the timing depends on the MAP. Smoother running engines have more vacuum and that yields more timing advance.

Be aware that the indicated timing is dependent on the accuracy of the timing marks.

Use a conventional "clip-on" inductive timing light to verify the timing accuracy and range. Only use a simple strobe light that does not have a potentiometer or display. The Plasma CDI's waste-spark ignition will give erroneous readings on these strobe lights. Always use only the timing marks on the engine side of the flywheel. The reference for this is the split line of the case.

The flywheel or prop extension must be graduated with the proper timing marks. TDC, 20 degrees, and 25 degrees BTDC markings are stamped on the flywheel engine side by the factory. Add markings at 35, 40, and 45 degrees. On 4-cyl engines, these markings should be duplicated 180 degrees out to reference the other ignition coil timing. On 6-cyl engines, the factory timing marks should be duplicated twice, 120 degrees and 240 degrees from TDC.

Make a pointer in line with the case seam to help define your reference. Then, point the timing light from the cockpit in line with the center of the case, and your pointer, at the timing marks on the flywheel.



Connect the strobe light lead to one of your high-tension leads (spark plug wires).

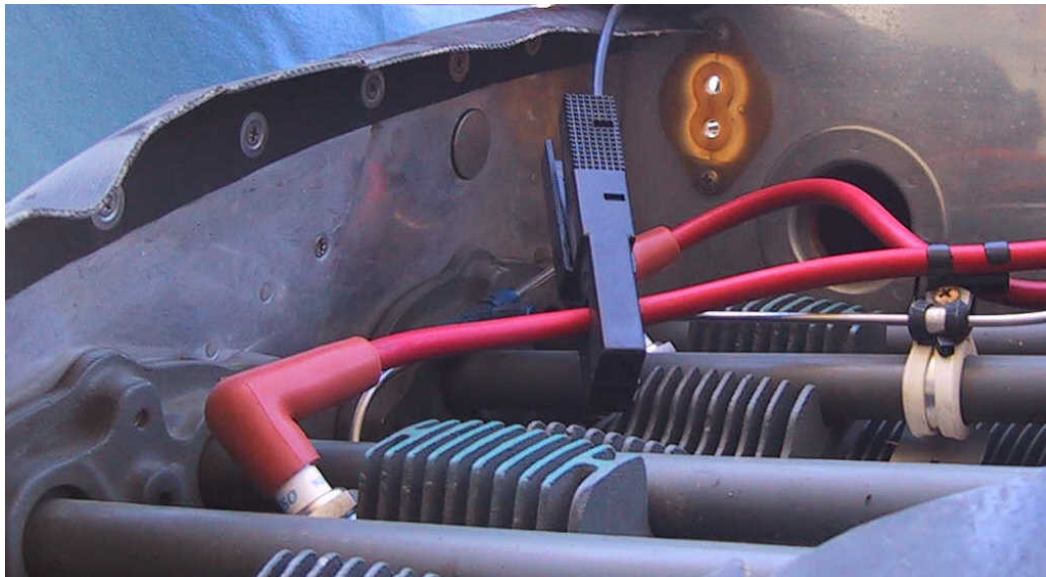

Connect the strobe light to power.

Check to confirm that manifold pressure is connected to your Plasma CD ignition box.

Start the engine. *The strobe light tests should be at engine idle, 600 - 900 rpm.*

Referencing the split line of the case and your pointer, make a written note of the actual ignition timing as seen with the timing light. This timing, with the manifold pressure connected to the box, is the most advanced position.

Now, disconnect the manifold pressure hose from the Plasma CD box and check the timing with the timing light. Make a written note of the ignition timing; this is the most retarded position.

Clip the timing light pickup to one of the ignition leads from the coil firing the next 2 opposing cylinders. The timing light should illuminate the opposite set of timing marks on the flywheel.

Check the ignition timing with the manifold pressure hose connected and with it disconnected. If you are using a cockpit timing indication, calibrate that indication with the strobe light value.

If you have a 6-cyl engine, you should check the timing on the coil firing the last 2 opposing cylinders using the same procedure.

Compare the timing of each coil.

It is easier to read the timing illumination out of direct sunlight.

Verify the timing is set to the proper values for your engine.

If not, adjust:

- In the case of the DC Mini Sensor, adjust the timing by using a different magnet ring with the leading magnets in a different location.
- In the case of a Hall Effect Module, this can be accomplished by rotating the sensor module in the accessory case.
- Adjust the Direct Crank Sensor system by loosening the screws that hold the circuit board to the mounting bracket and rotating the circuit board.

When finished, secure all hardware with Loctite or safety wire and the proper torque.

FLOWCHART 1: TROUBLESHOOTING- ENGINE RUNS POORLY

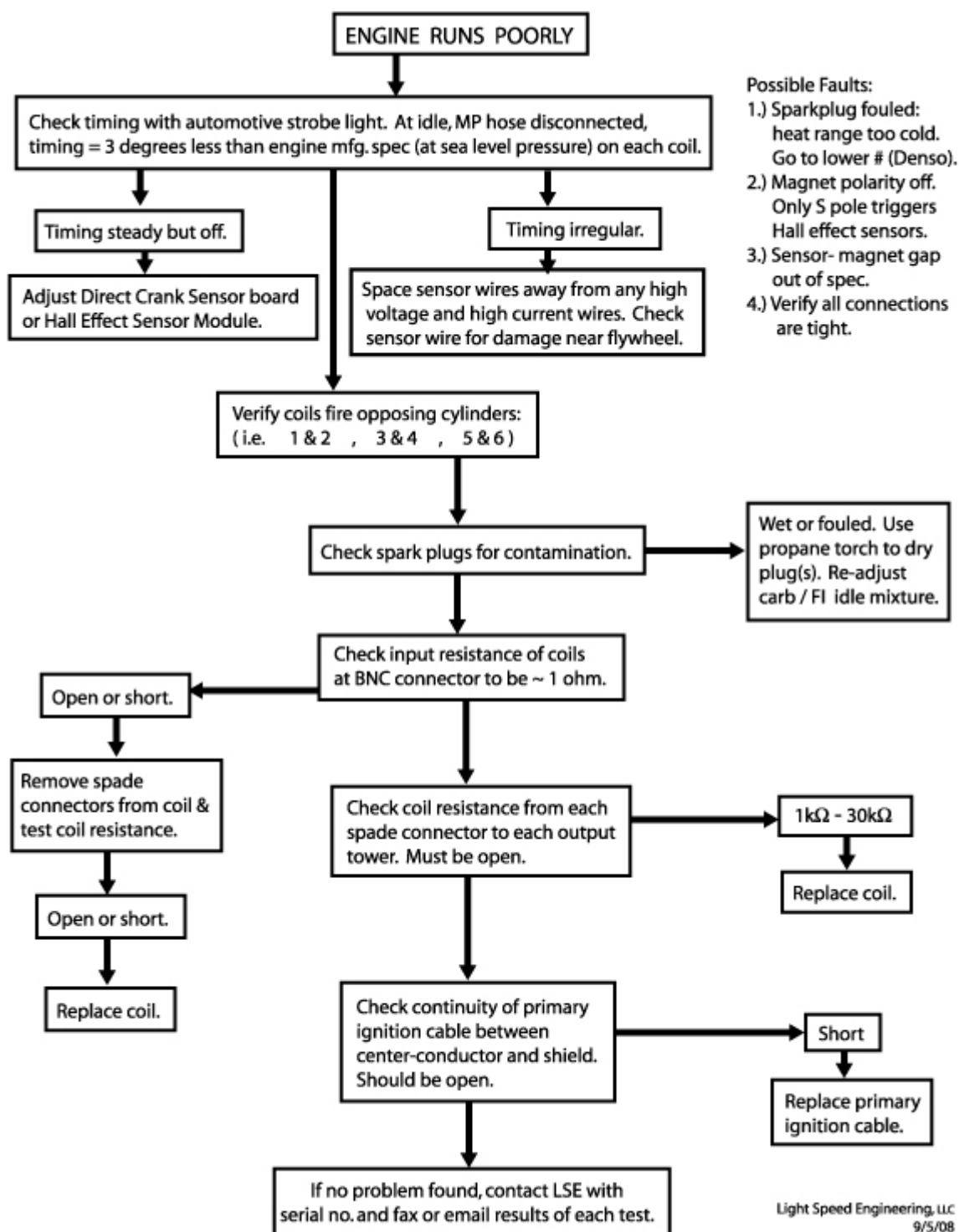

FLOWCHART 2: TROUBLESHOOTING- ENGINE DOES NOT RUN

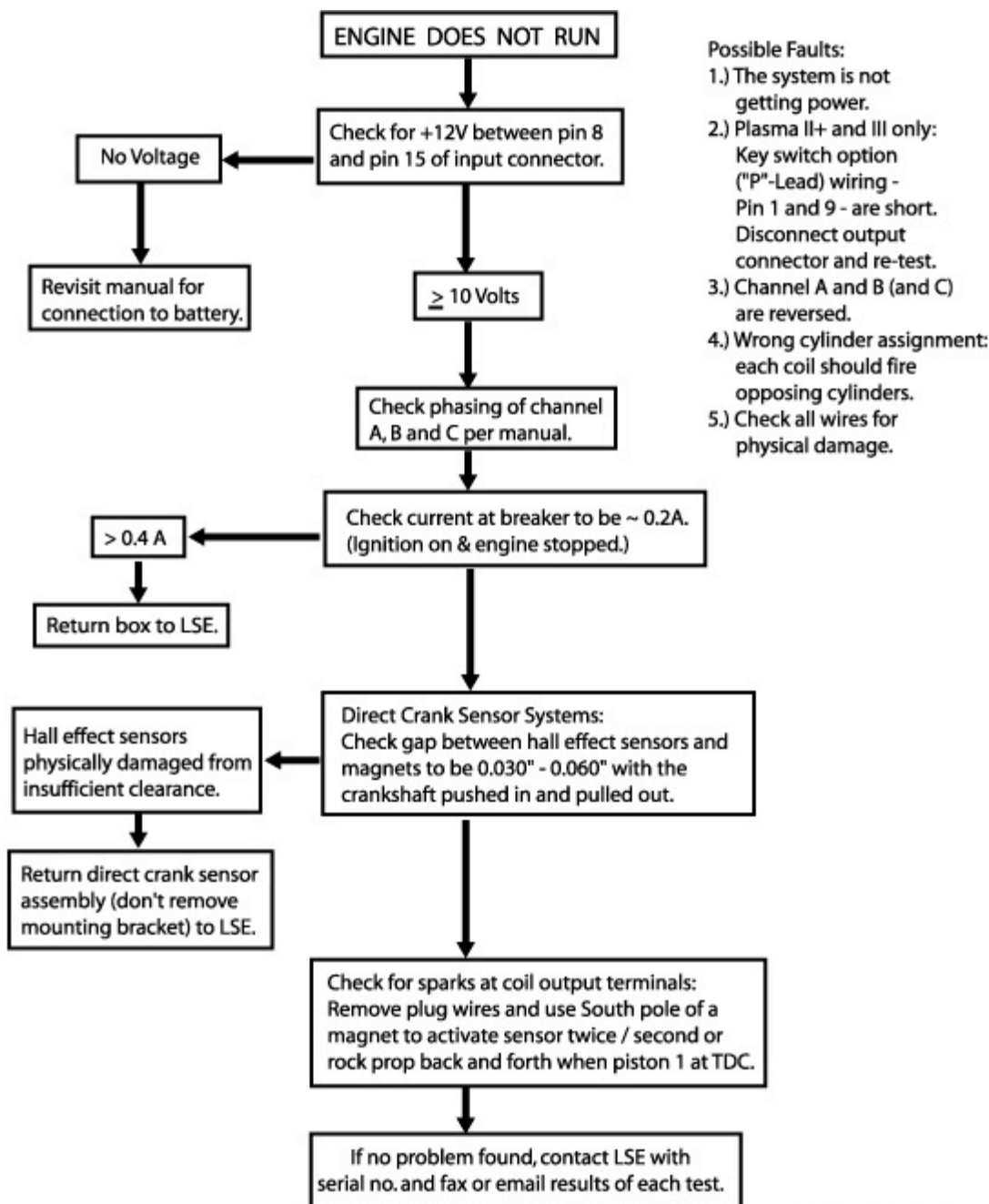

Section 8 FACTORY REPAIR AND WARRANTY

Limited Warranty: Light Speed Engineering products are warranted to be free from defects in materials or workmanship for a period of six (6) months from the date of installation or one (1) year from the date of purchase, whichever occurs first. If within the applicable period, a Light Speed Engineering product is proved to Light Speed Engineering's satisfaction to be defective in materials or workmanship, then the product will be repaired or replaced, or the purchase price refunded, at Light Speed Engineering's sole discretion. The exclusive remedy for defects and materials, and Light Speed Engineering's sole obligation with respect to defects in materials or workmanship, shall be limited to such repair, replacement FOB Light Speed Engineering's headquarters, or refund of the purchase price, and shall be conditioned upon Light Speed Engineering's receipt of notice of the alleged defects within thirty (30) days after its discovery, and at Light Speed Engineering's option, return of the product(s) prepaid to its headquarters. This warranty shall not apply or extend to any product that has been misused, mishandled, modified, or adjusted, or if any electronic components of the product have been opened, disassembled, or otherwise tampered with, whether by the purchaser or others. THIS LIMITED WARRANTY IS IN LIEU OF ALL OTHER WARRANTIES, EXPRESS OR IMPLIED, INCLUDING, WITHOUT LIMITATION, THE IMPLIED WARRANTIES OF MERCHANTABILITY AND FITNESS FOR A PARTICULAR PURPOSE, ALL OF WHICH OTHER WARRANTIES ARE EXPRESSLY DISCLAIMED.

Liability: The obligations of Light Speed Engineering are strictly limited to the limited warranty described above, and Light Speed Engineering shall not be liable for any other obligations or liabilities whatsoever, including but not limited to incidental, consequential, punitive or special damages, or any lost revenues or profits, lost use of equipment, damage to equipment or other property, cost of substitute products, costs of product removal, claims to third parties relating thereto, or any other damages whether based on contract, negligence, tort, or any strict liability theory.

Returns: Products with alleged defects in materials or workmanship may be returned for repair, replacement or refund (at our option) pursuant to the foregoing limited warranty only if a return authorization is obtained.

You may obtain a return authorization by calling Light Speed Engineering at (805) 933-3299.

For further information or questions concerning our products, please e-mail klaus@lightspeedengineering.com or contact us at:

Light Speed Engineering, LLC
MAIL: PO Box 549, Santa Paula, CA, 93061
UPS/FedEX Physical Address: 416 E. Santa Maria St. #15, Santa Paula, CA, 93060
Phone: (805) 933-3299

This page was last updated 03/15/2013.

Copyright © 2006 LSE, LLC. All rights reserved.

FIGURE 1: DUAL POWER SUPPLY DIAGRAM

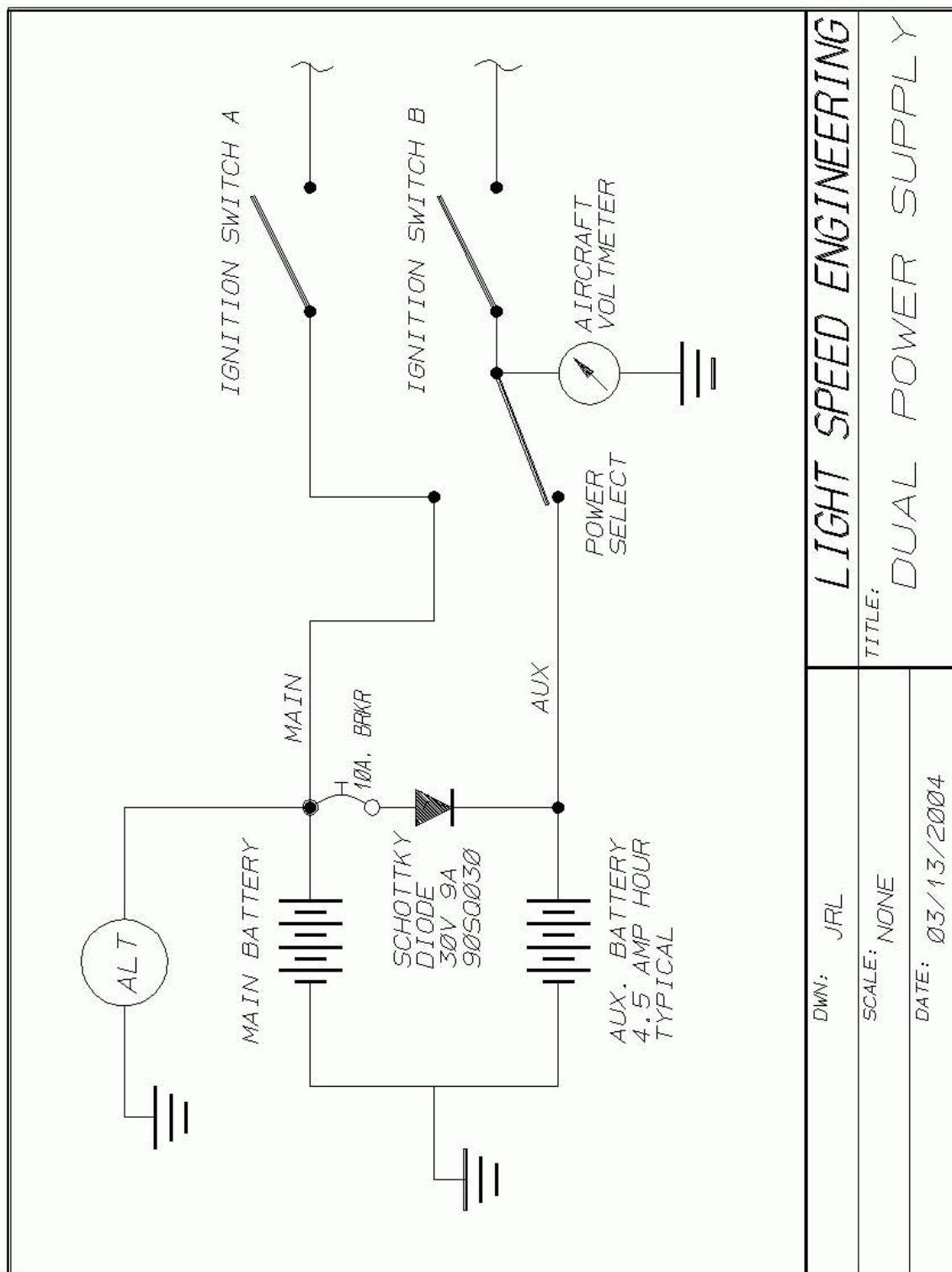
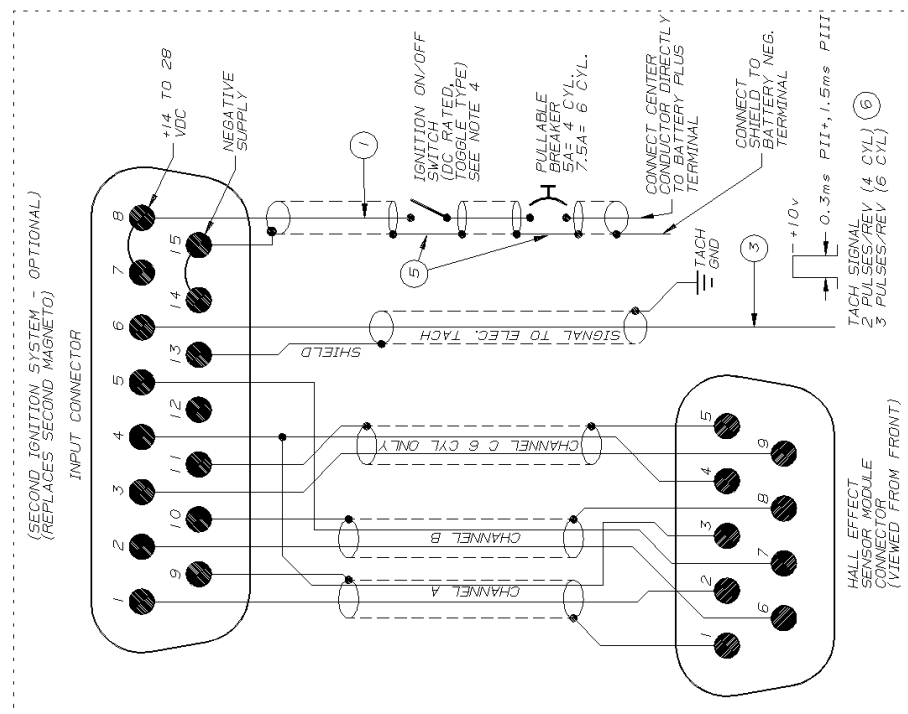
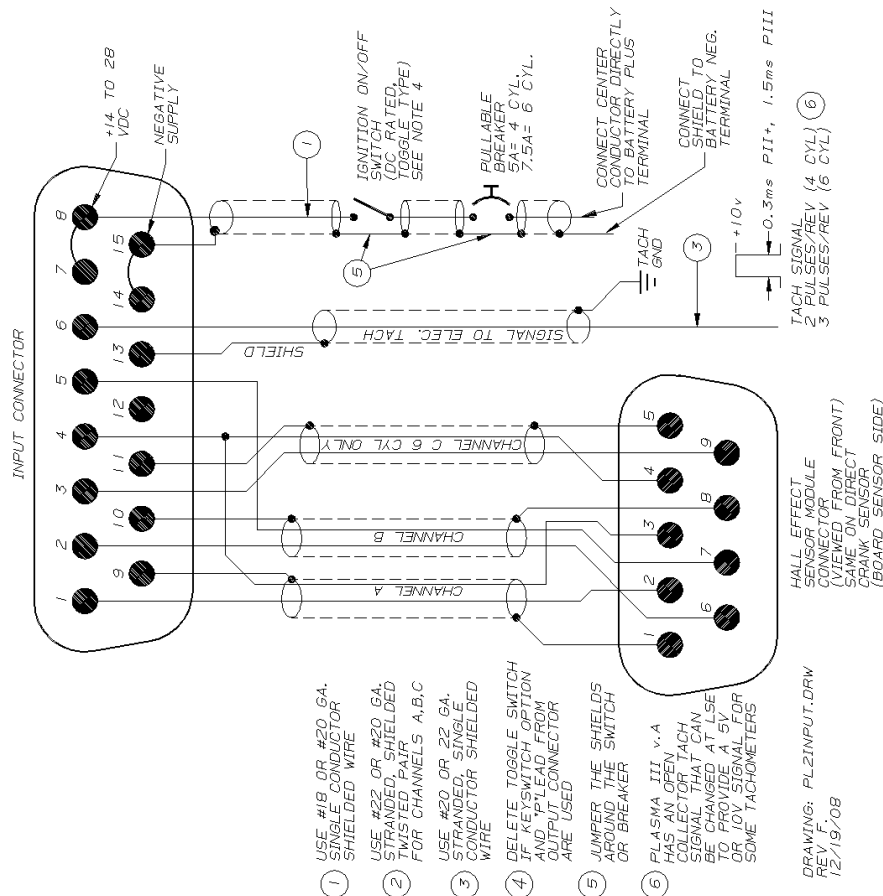

FIGURE 2: INPUT CONNECTOR DIAGRAM



PLASMA II, PLASMA II PLUS, AND PLASMA III



- 1 USE #18 OR #20 GA. SINGLE CONDUCTOR SHIELDED WIRE
- 2 USE #22 OR #20 GA. GROUND SHIELDED TWISTED PAIR FOR CHANNELS A,B,C
- 3 USE #20 OR #22 GA. STRANDED, SINGLE CONDUCTOR SHIELDED WIRE
- 4 DELETE TOGGLE SWITCH AND "P" LEAD FROM OUTPUT CONNECTOR ARE USED
- 5 JUMPER THE SHIELDS AROUND THE SWITCH OR BREAKER
- 6 PLASMA III v.4 HAS AN OPEN COLLECTOR TACH SIGNAL THAT CAN BE MADE A USE TO PROVIDE A USE OR IOV SIGNAL FOR SOME TACHOMETERS

DRAWING: PL2INPUT.DRW
REV: 15/08

FIGURE 4: DUAL IGNITION INDICATOR LIGHTS